

BRAUN

SnackMaker 5



SM 5000
SM 5001
SM 5005
SM 5006
SM 5038

Register your product
www.braunhousehold.com/register

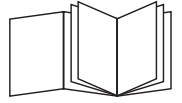

RO- Înainte de a utiliza aparatul pentru prima oară, citiți cu atenție pliantul separat cu instrucțiuni de siguranță

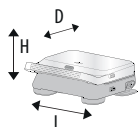
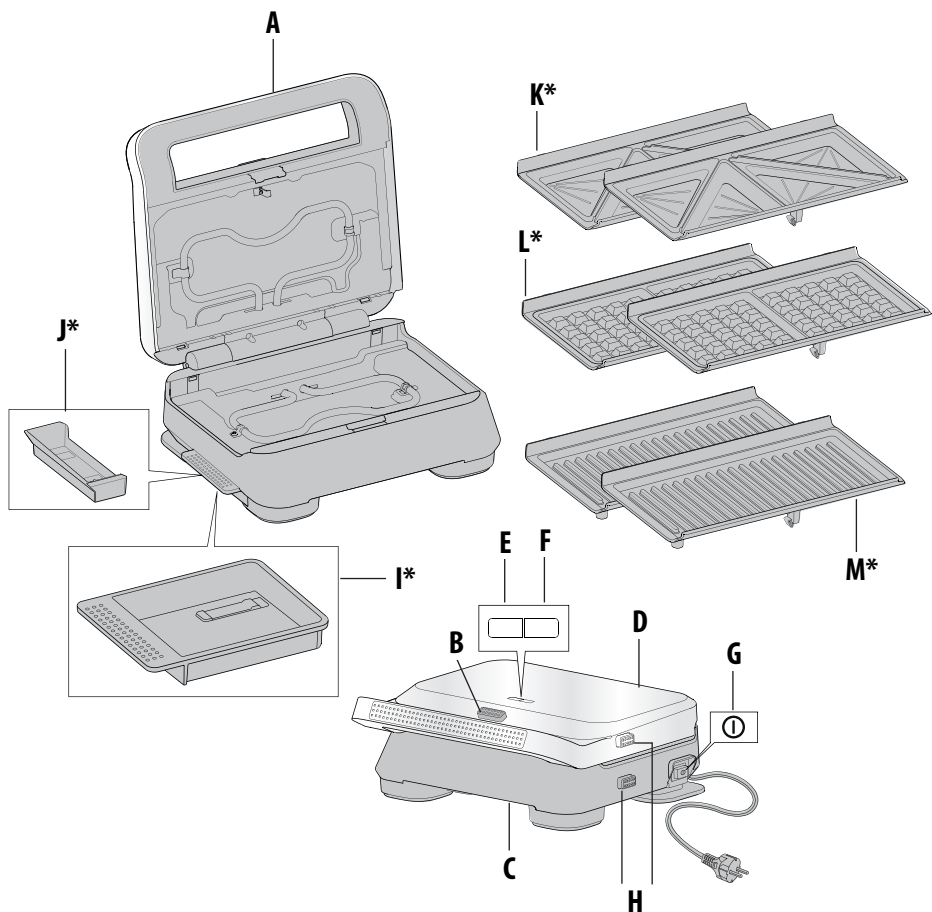

(LxHxD): **SM5001 (M* - I*)** - 290x105x250 mm
SM5000 (K* - J*) - 275x105x250 mm
SM5006 (L* - M* - I*) - 290x105x250 mm
SM5005 (K* - L* - J*) - 275x105x250 mm
SM5038 (K* - L* - M* - I*) - 290x105x250 mm

~ 220-240 V ~ 50-60 Hz 800W

■ **SM5001** 2.716 kg - **SM5000** 2.572 kg -
SM5006 3.340 kg - **SM5005** 3.196 kg - **SM5038** 3.920 kg

* **RO-** În funcție de model și/sau de disponibilitățile din magazin sau on line.

RO DESCRIERE

- A** Mâner
- B** Buton de deblocare
- C** Bază
- D** Capac superior
- E** Led roșu (aparat în curs de încălzire)
- F** Led verde (aparat pregătit pentru utilizare)
- G** Întrerupător On/Off
- H** Butoane de decuplare a plăcilor
- I*** Tavă de colectare a grăsimilor (doar pe anumite modele)
- J*** Capac (doar pe anumite modele)
- K*** Plăci de sandvici (doar pe anumite modele)
- L*** Plăci pentru vafe (doar pe anumite modele)
- M*** Plăci de grătar (doar pe anumite modele)

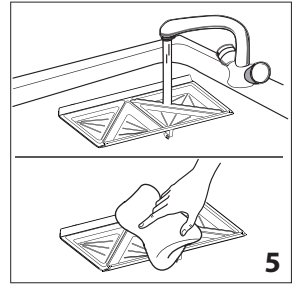
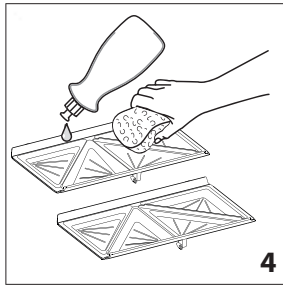
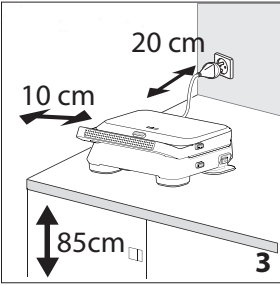
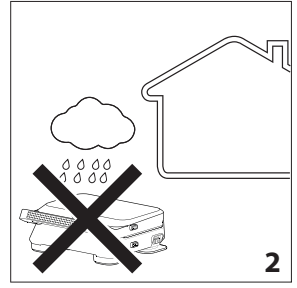
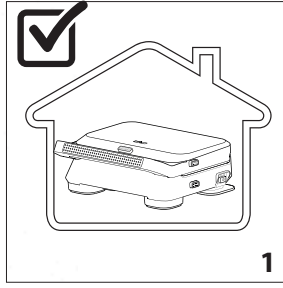

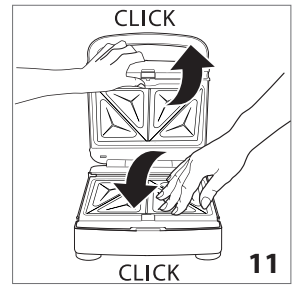
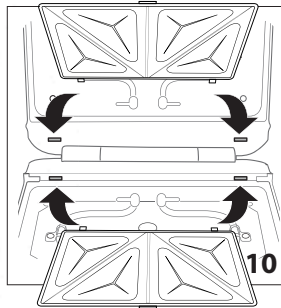
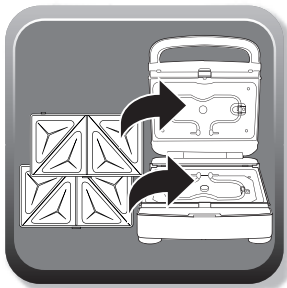
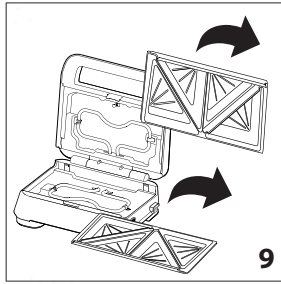
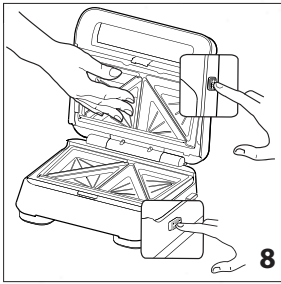
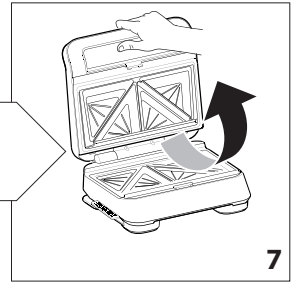
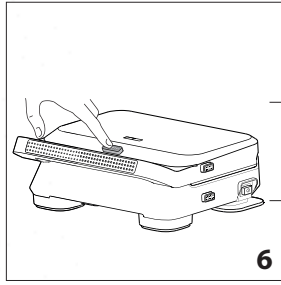
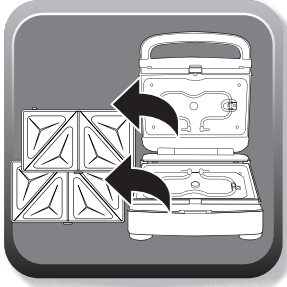

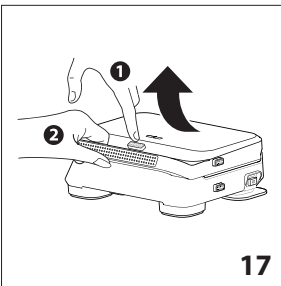
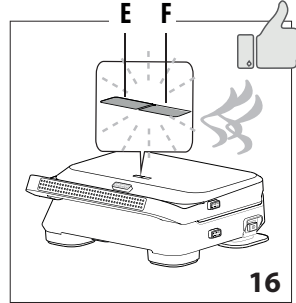
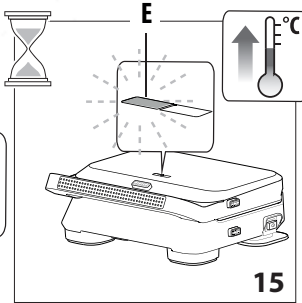
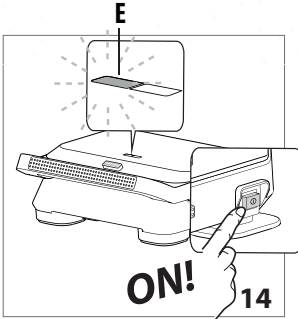
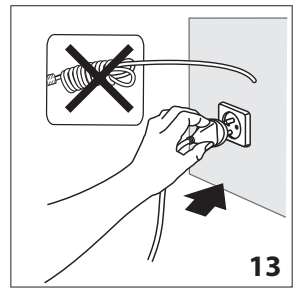
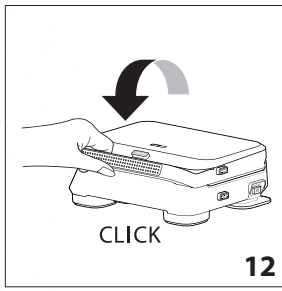
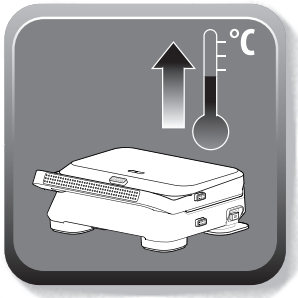

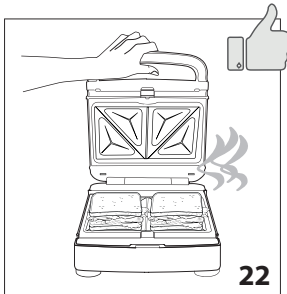
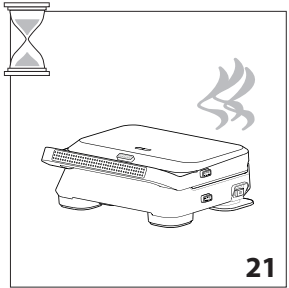
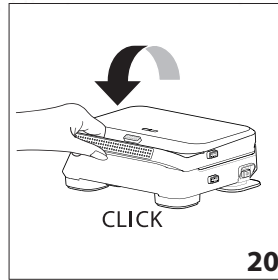
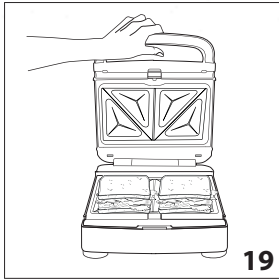
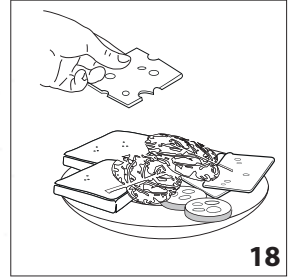
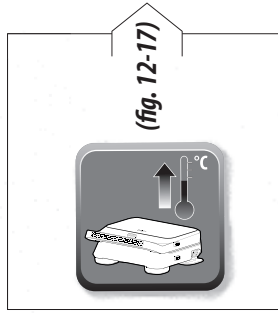
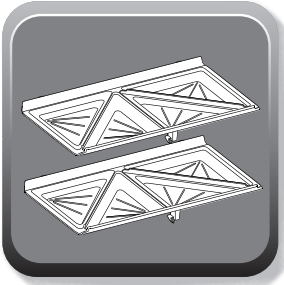

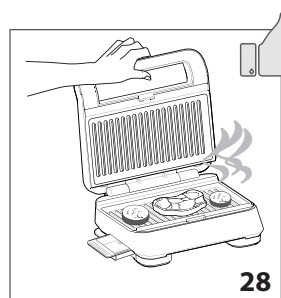
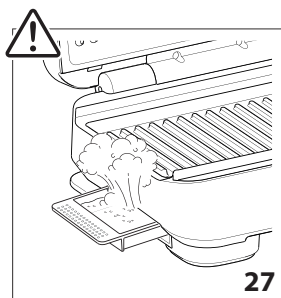
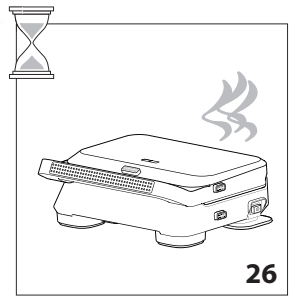
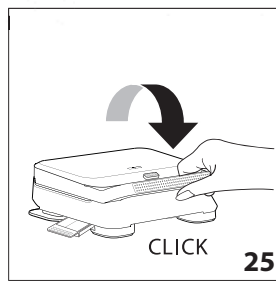
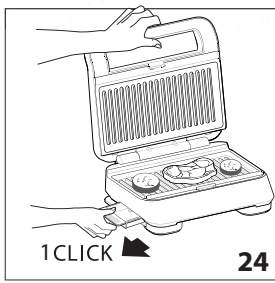
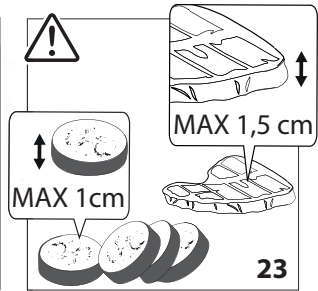
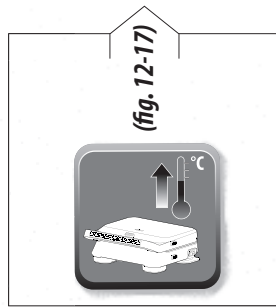
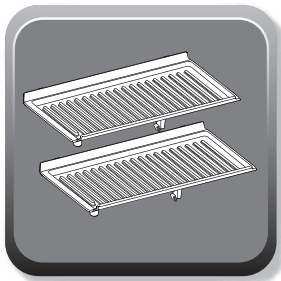

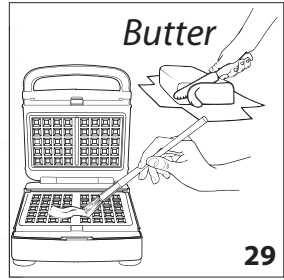
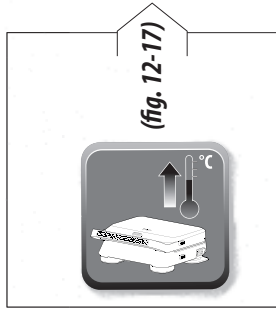
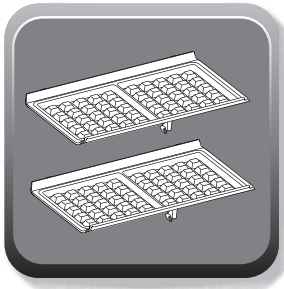

29

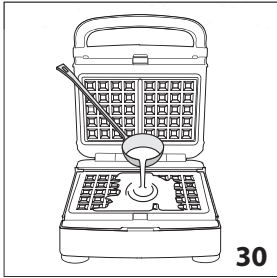

30

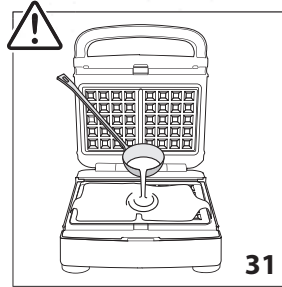

31

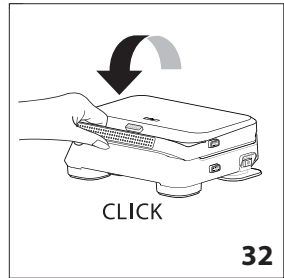

CLICK

32

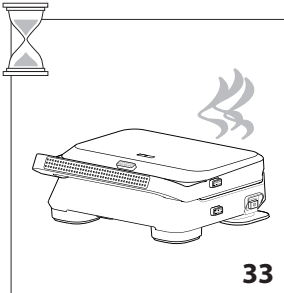

33

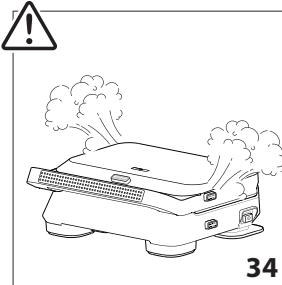

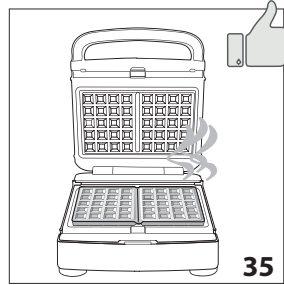

34

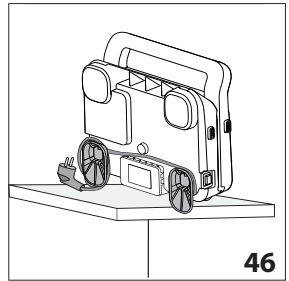
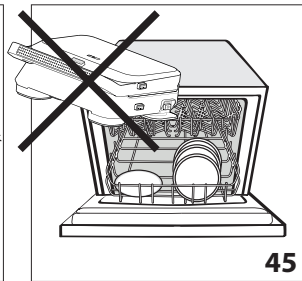
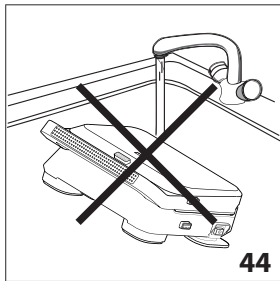
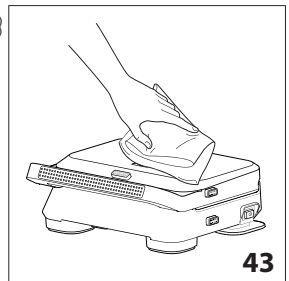
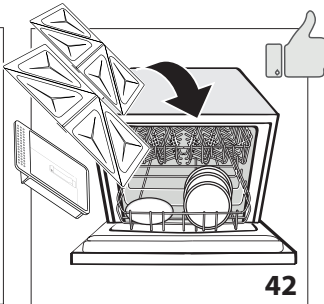
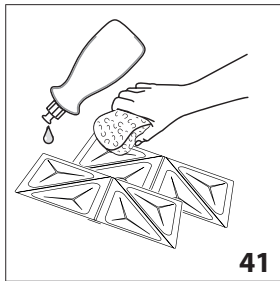
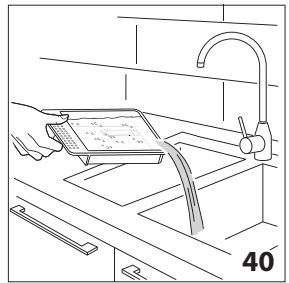
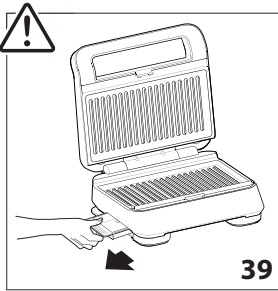
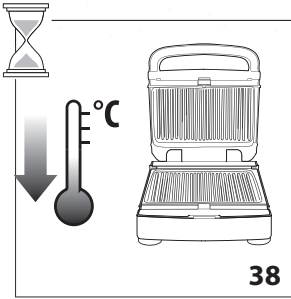
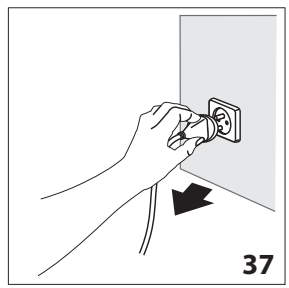
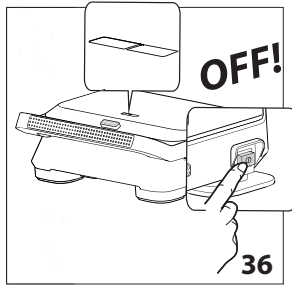

35

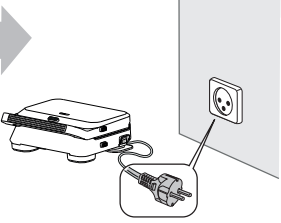
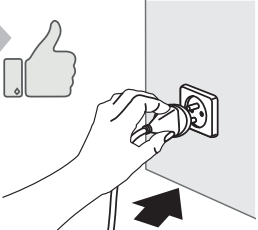
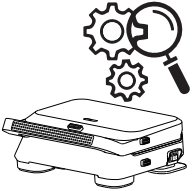
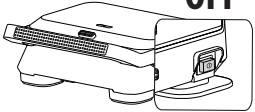
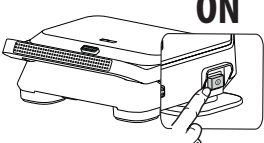

?	⚠	✓
	 → 	
	→  OFF	→  ON
	→ 	→  Service